

Section O

Wallplates

INDEX

PAGE

Nylon and Metal

Product Features O-2

Snap-On Wallplates

Decorator and Toggle O-3

Standard, Mid-Size and Jumbo Wallplates

Decorator O-4

Toggle O-5

Duplex and Single Receptacle O-6

Telephone and Coaxial O-8

“D” Hole O-9

Blank O-10

Combination O-11

Data Communication and Louver O-14

Jumbo Metal O-15

Custom Metal O-16

Premarked and Specialty O-18

Barrel Key Switch and Accessories O-19

Technical

Selection Chart O-20

Dimensions and Material Specifications O-21

Weatherproof Covers

Zinc Die Cast, 1- and 2-Gang, Vertical or Horizontal Mount O-22

Zinc Die Cast Alluminum and Non-Metallic, 1-Gang, Vertical Mount O-23

Non-Metallic, 1- and 2-Gang, Vertical Mount for Flanged Devices O-24

Non-Metallic, 1- and 2-Gang, While-In-Use O-25

Pool Pump and Generator Kits

Pool Pump Receptacle Kit O-26

Generator Power Connection Kit O-26

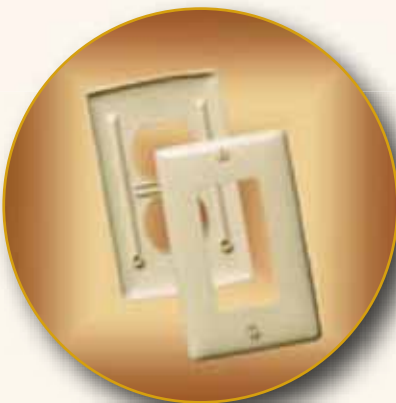

Wallplates

Product Features



Wallplates bring an unparalleled combination of features, benefits and advantages. They are elegant enough for the home and tough enough to withstand the most rigorous environments.

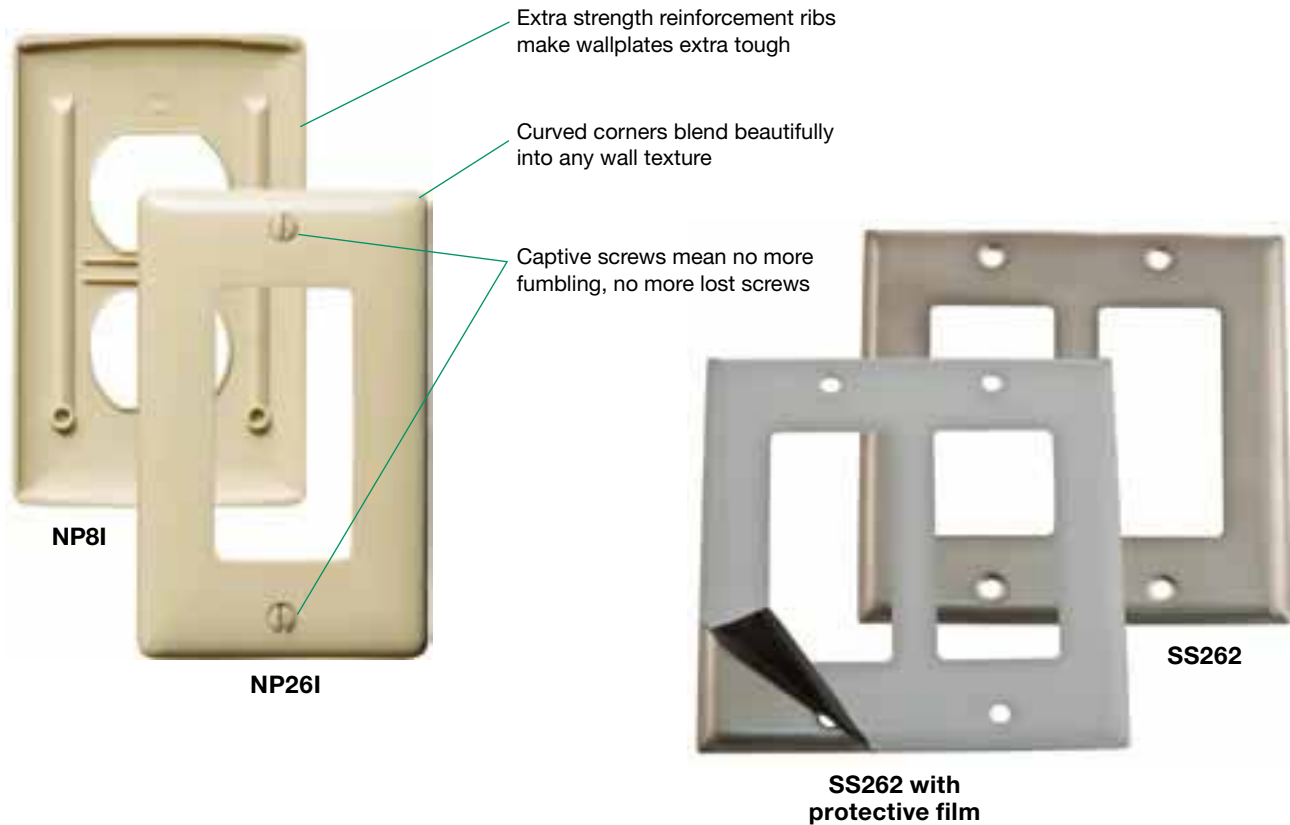

Nylon Wallplates

Nylon wallplates are designed for durability and easy cleaning. Standard sized wallplates are $\frac{1}{8}$ inch larger to give you that extra coverage to hide rough box openings. The depth is $\frac{1}{4}$ inch so that it will comfortably fit over the device even on imperfect installations or on retrofit work.

- Nylon wallplate is virtually unbreakable
- Smooth finish is easy to clean

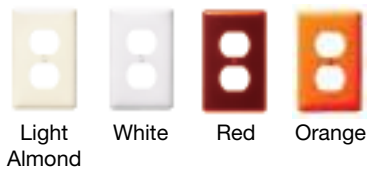
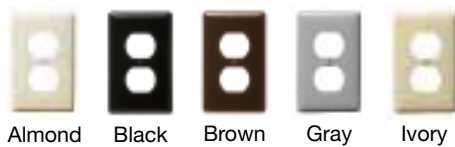

Metal Wallplates

Aluminum

- Non-magnetic for static free requirements
- Corrosion resistant

Brass

- Plush finish coated to inhibit oxidation

Metallic Plated Steel

- Available in either chrome or brass finishes

302/304 Stainless Steel (18.0% Chromium, 8.0% Nickel)

- Non-magnetic for static-free requirements
- For use in Industrial and Commercial applications exposed to highly corrosive environments
- Brushed finish

430 Stainless Steel (17.0% Chromium, less than .50% Nickel)

- Magnetic
- For use in Industrial and Commercial applications where corrosion resistance is less critical
- Brushed finish



Aluminum Brass Brass Plated Chrome Plated 302/304 S/S 430 S/S

Note: All metal wallplates (except brass) are packaged with a white protective film; which protects the wallplate during installation and is easily peeled off.

Wallplates

Snap-On Wallplates



Decorator snap-on wallplates offer a clean, elegant look that can be installed in seconds. Toggle snap-on wallplates offer traditional styling, two piece construction, and four snaps that securely hold the cover to the sub-plate.

- Smooth finish
- Virtually unbreakable thermoplastic
- Easy to snap-on
- Multi-gang auto alignment

DECORATOR AND TOGGLE

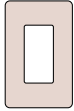
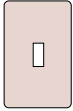
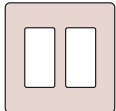
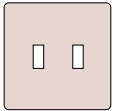
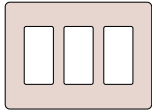
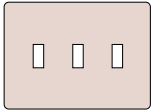
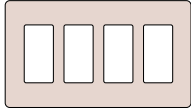
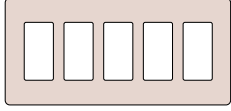
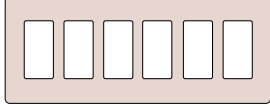
Description	Color	Catalog Number	
		Decorator	Toggle
1-Gang  	Almond Ivory Light Almond White	RCW1AL RCW1I RCW1LA RCW1W	— RFW1I — RFW1W
2-Gang  	Almond Ivory Light Almond White	RCW2AL RCW2I RCW2LA RCW2W	— RFW2I — RFW2W
3-Gang  	Almond Ivory Light Almond White	RCW3AL RCW3I RCW3LA RCW3W	— RFW3I — RFW3W
4-Gang 	Almond Ivory Light Almond White	RCW4AL RCW4I RCW4LA RCW4W	— — — —
5-Gang 	Almond Ivory Light Almond White	RCW5AL RCW5I RCW5LA RCW5W	— — — —
6-Gang 	Almond Ivory Light Almond White	RCW6AL RCW6I RCW6LA RCW6W	— — — —

PRODUCT DIMENSIONS Inches (mm)

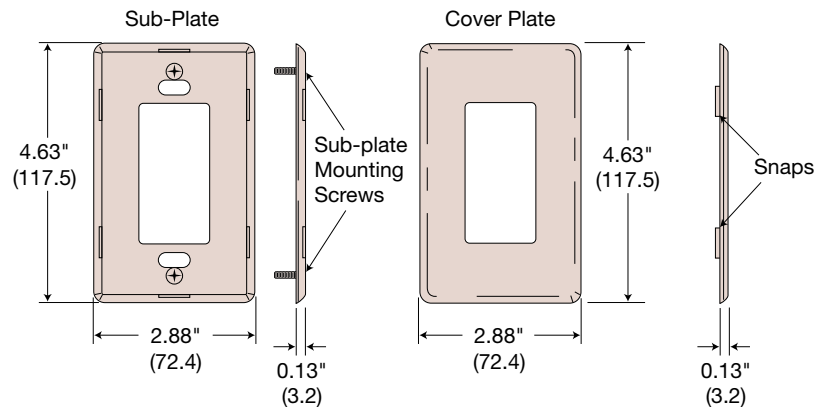

DECORATOR WALLPLATES

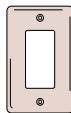
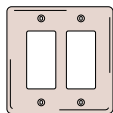
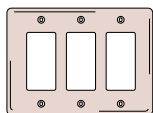
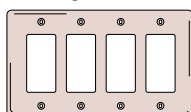
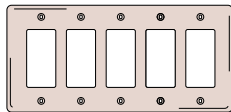
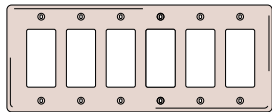
Description	Nylon Color	Standard	Mid-Size	Material	Metal
 1-Gang	Almond Black Brown Gray Ivory Light Almond Red White	NP26AL NP26BK NP26 NP26GY NP26I NP26LA NP26R NP26W	NPJ26AL NPJ26BK NPJ26 NPJ26GY NPJ26I NPJ26LA NPJ26R NPJ26W	Aluminum Brass Brass Plated Chrome 302/304 S/S 430 S/S	① SB26 SBP26 SCH26 SS26 SS26L
 2-Gang	Almond Black Brown Gray Ivory Light Almond Red White	NP262AL NP262BK NP262 NP262GY NP262I NP262LA NP262R NP262W	NPJ262AL NPJ262BK NPJ262 NPJ262GY NPJ262I NPJ262LA NPJ262R NPJ262W	Aluminum Brass Brass Plated Chrome 302/304 S/S 430 S/S	① SB262 SBP262 SCH262 SS262 SS262L
 3-Gang	Almond Black Brown Gray Ivory Light Almond Red White	NP263AL NP263BK NP263 NP263GY NP263I NP263LA NP263R NP263W	NPJ263AL NPJ263BK NPJ263 NPJ263GY NPJ263I NPJ263LA NPJ263R NPJ263W	Aluminum Brass Brass Plated Chrome 302/304 S/S 430 S/S	① ① SBP263 ① SS263 ①
 4-Gang	Almond Black Brown Gray Ivory Light Almond Red White	NP264AL NP264BK NP264 NP264GY NP264I NP264LA NP264R NP264W	NPJ264AL NPJ264BK NPJ264 NPJ264GY NPJ264I NPJ264LA NPJ264R NPJ264W	Aluminum Brass Brass Plated Chrome 302/304 S/S 430 S/S	① ① ① ① SS264 ①
 5-Gang	Almond Black Brown Gray Ivory Light Almond Red White	NP265AL NP265BK NP265 NP265GY NP265I NP265LA — NP265W	— — — — — — — —	Aluminum Brass Brass Plated Chrome 302/304 S/S 430 S/S	① ① ① ① SS265 ①
 6-Gang	Almond Black Brown Gray Ivory Light Almond Red White	NP266AL NP266BK NP266 NP266GY NP266I NP266LA — NP266W	— — — — — — — —	Aluminum Brass Brass Plated Chrome 302/304 S/S 430 S/S	① ① ① ① SS266 ①

Note: All standard and mid-size nylon wallplates feature pre-inserted captive screws for faster assembly.
 ① Available as a custom wallplate; see page O-16.

PRODUCT DIMENSIONS Inches (mm)

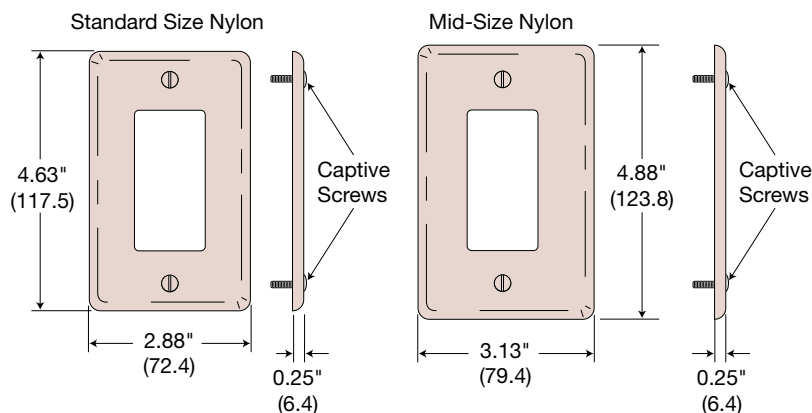





Wallplates

Toggle Switch Wallplates

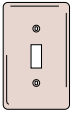
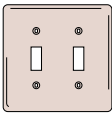
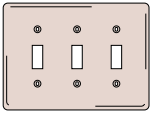
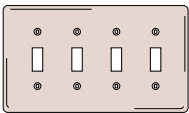
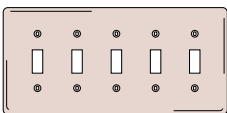
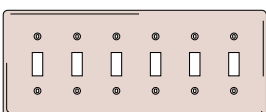

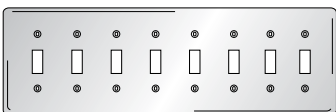
TOGGLE WALLPLATES

Description	Nylon Color	Standard	Mid-Size	Material	Metal
	Almond	NP1AL	NPJ1AL	Aluminum	SA1
	Black	NP1BK	NPJ1BK	Brass	SB1
	Brown	NP1	NPJ1	Brass Plated	SBP1
	Gray	NP1GY	NPJ1GY	Chrome	SCH1
	Ivory	NP1I	NPJ1I	302/304 S/S	SS1
	Light Almond	NP1LA	NPJ1LA	430 S/S	SS1L
	Red	NP1R	NPJ1R		
	White	NP1W	NPJ1W		
	Almond	NP2AL	NPJ2AL	Aluminum	SA2
	Black	NP2BK	NPJ2BK	Brass	SB2
	Brown	NP2	NPJ2	Brass Plated	SBP2
	Gray	NP2GY	NPJ2GY	Chrome	SCH2
	Ivory	NP2I	NPJ2I	302/304 S/S	SS2
	Light Almond	NP2LA	NPJ2LA	430 S/S	SS2L
	Red	NP2R	NPJ2R		
	White	NP2W	NPJ2W		
	Almond	NP3AL	NPJ3AL	Aluminum	①
	Black	NP3BK	NPJ3BK	Brass	SB3
	Brown	NP3	NPJ3	Brass Plated	SBP3
	Gray	NP3GY	NPJ3GY	Chrome	SCH3
	Ivory	NP3I	NPJ3I	302/304 S/S	SS3
	Light Almond	NP3LA	NPJ3LA	430 S/S	SS3L
	Red	NP3R	NPJ3R		
	White	NP3W	NPJ3W		
	Almond	NP4AL	NPJ4AL	Aluminum	①
	Black	NP4BK	NPJ4BK	Brass	SB4
	Brown	NP4	NPJ4	Brass Plated	SBP4
	Gray	NP4GY	NPJ4GY	Chrome	①
	Ivory	NP4I	NPJ4I	302/304 S/S	SS4
	Light Almond	NP4LA	NPJ4LA	430 S/S	SS4L
	Red	—	—		
	White	NP4W	NPJ4W		
	Almond	NP5AL	—	Aluminum	①
	Black	NP5BK	—	Brass	SB5
	Brown	NP5	—	Brass Plated	①
	Gray	NP5GY	—	Chrome	①
	Ivory	NP5I	—	302/304 S/S	SS5
	Light Almond	NP5LA	—	430 S/S	①
	Red	—	—		
	White	NP5W	—		
	Almond	NP6AL	—	Aluminum	①
	Black	—	—	Brass	SB6
	Brown	NP6	—	Brass Plated	①
	Gray	NP6GY	—	Chrome	①
	Ivory	NP6I	—	302/304 S/S	SS6
	Light Almond	NP6LA	—	430 S/S	①
	Red	—	—		
	White	NP6W	—		
	Almond	—	—	Aluminum	①
	Black	—	—	Brass	①
	Brown	—	—	Brass Plated	①
	Gray	—	—	Chrome	①
	Ivory	—	—	302/304 S/S	SS607
	Light Almond	—	—	430 S/S	①
	Red	—	—		
	White	—	—		
	Almond	—	—	Aluminum	①
	Black	—	—	Brass	①
	Brown	—	—	Brass Plated	①
	Gray	—	—	Chrome	①
	Ivory	—	—	302/304 S/S	SS608
	Light Almond	—	—	430 S/S	①
	Red	—	—		
	White	—	—		
	Almond	—	—	Aluminum	—
	Black	—	—	Brass	—
	Brown	—	—	Brass Plated	—
	Gray	—	—	Chrome	—
	Ivory	—	—	302/304 S/S	SS740
	Light Almond	—	—	430 S/S	—
	Red	—	—		
	White	—	—		

Note: All standard and mid-size nylon wallplates feature pre-inserted captive screws for faster assembly.



① Available as a custom wallplate; see page O-16.

Wallplates



Duplex and Single Receptacle Wallplates

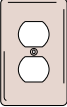
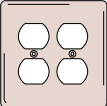
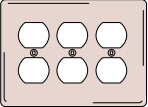
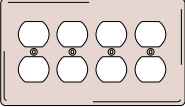

DUPLEX RECEPTACLE WALLPLATES

Description	Nylon Color	Standard	Mid-Size	Material	Metal
 1-Gang	Almond	NP8AL	NPJ8AL	Aluminum	SA8
	Black	NP8BK	NPJ8BK	Brass	SB8
	Brown	NP8	NPJ8	Brass Plated	SBP8
	Gray	NP8GY	NPJ8GY	Chrome	SCH8
	Ivory	NP8I	NPJ8I	302/304 S/S	SS8
	Light Almond	NP8LA	NPJ8LA	430 S/S	SS8L
	Office White	NP8OW	NPJ8OW		
	Orange	NP8OR	—		
	Red	NP8R	NPJ8R		
	White	NP8W	NPJ8W		
	 2-Gang	Almond	NP82AL	NPJ82AL	Aluminum
Black		NP82BK	NPJ82BK	Brass	SB82
Brown		NP82	NPJ82	Brass Plated	SBP82
Gray		NP82GY	NPJ82GY	Chrome	SCH82
Ivory		NP82I	NPJ82I	302/304 S/S	SS82
Light Almond		NP82LA	NPJ82LA	430 S/S	SS82L
Office White		NP82OW	NPJ82OW		
Orange		NP82OR	—		
Red		NP82R	NPJ82R		
White		NP82W	NPJ82W		
 3-Gang		Almond	NP83AL	—	Aluminum
	Black	NP83BK	—	Brass	SB83
	Brown	NP83	—	Brass Plated	SBP83
	Gray	NP83GY	—	Chrome	①
	Ivory	NP83I	—	302/304 S/S	SS83
	White	NP83W	—	430 S/S	①
 4-Gang	Almond	NP84AL	—	Aluminum	①
	Black	NP84BK	—	Brass	①
	Brown	NP84	—	Brass Plated	①
	Gray	NP84GY	—	Chrome	①
	Ivory	NP84I	—	302/304 S/S	SS84
	White	NP84W	—	430 S/S	①
	 2-Gang; 1-duplex	Almond	—	—	Aluminum
Black		—	—	Brass	—
Brown		—	—	Brass Plated	—
Gray		—	—	Chrome	—
Ivory		—	—	302/304 S/S	SS748
White		—	—	430 S/S	—

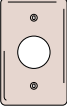
SINGLE RECEPTACLE WALLPLATES Inches (mm)

Description	Nylon Color	Standard	Mid-Size	Material	Metal
 1-Gang; 1-single; 1.40 in. (35.6) diameter opening	Almond	NP7AL	NPJ7AL	Aluminum	SA7
	Black	NP7BK	NPJ7BK	Brass	SB7
	Brown	NP7	NPJ7	Brass Plated	SBP7
	Gray	NP7GY	NPJ7GY	Chrome	SCH7
	Ivory	NP7I	NPJ7I	302/304 S/S	SS7
	Light Almond	NP7LA	NPJ7LA	430 S/S	SS7L
	Red	NP7R	NPJ7R		
	White	NP7W	NPJ7W		
	 2-Gang; 1-single; 1.40 in. (35.6) diameter opening	Almond	—	—	Aluminum
Black		—	—	Brass	—
Brown		—	—	Brass Plated	—
Gray		—	—	Chrome	—
Ivory		—	—	302/304 S/S	SS747
White		—	—	430 S/S	—
 2-Gang; 2-single; 1.40 in. (35.6) diameter openings	Almond	—	—	Aluminum	SA72
	Black	—	—	Brass	SB72
	Brown	—	—	Brass Plated	①
	Gray	—	—	Chrome	①
	Ivory	—	—	302/304 S/S	SS72
	White	—	—	430 S/S	①

Note: All standard and mid-size nylon wallplates feature pre-inserted captive screws for faster assembly.







① Available as a custom wallplate; see page O-16.

Wallplates

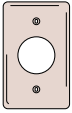
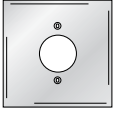
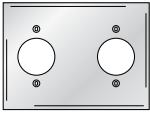
Single Receptacle Wallplates

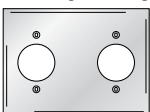

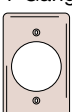
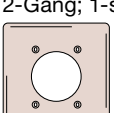
SINGLE RECEPTACLE WALLPLATES Inches (mm)

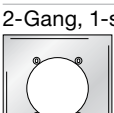
Description	Nylon Color	Standard	Mid-Size	Material	Metal
 1-Gang; 1-single; 1.60 in. (40.6) dia. opening; 20/30A locking devices	Almond	NP720AL	—	Aluminum	SA720
	Black	NP720BK	—	Brass	SB720
	Brown	NP720	—	Brass Plated	①
	Gray	NP720GY	—	Chrome	①
	Ivory	NP720I	—	302/304 S/S	SS720
	Office White	NP720OW	—	430 S/S	①
	Red	NP720R	—		
	White	NP720W	—		
 2-Gang; 1-single; 1.60 in. (40.6) dia. opening; 20/30A locking devices	Almond	—	—	Aluminum Brass	—
	Black	—	—	Brass Plated	—
	Brown	—	—	Chrome	—
	Gray	—	—	302/304 S/S	SS749
	Ivory	—	—	430 S/S	—
	White	—	—		
 3-Gang; 2-single; 1.60 in. (40.6) dia. opening; 20/30A locking devices	Almond	—	—	Aluminum Brass	—
	Black	—	—	Brass Plated	—
	Brown	—	—	Chrome	—
	Gray	—	—	302/304 S/S	SS320
	Ivory	—	—	430 S/S	—
	White	—	—		
 1-Gang; 1-single; 1.70 in. (43.2) dia. opening; 20/30A locking devices	Almond	—	—	Aluminum Brass	—
	Black	—	—	Brass Plated	—
	Brown	—	—	Chrome	—
	Gray	—	—	302/304 S/S	SS725
	Ivory	—	—	430 S/S	—
	White	—	—		
 3-Gang; 2-single; 1.70 in. (43.2) dia. opening; 20/30A locking devices	Almond	—	—	Aluminum Brass	—
	Black	—	—	Brass Plated	—
	Brown	—	—	Chrome	—
	Gray	—	—	302/304 S/S	SS330
	Ivory	—	—	430 S/S	—
	White	—	—		
 1-Gang; 1-single; 1.97 in. (50.0) dia. opening; 20/30A locking devices	Almond	—	—	Aluminum Brass	—
	Black	—	—	Brass Plated	—
	Brown	—	—	Chrome	—
	Gray	—	—	302/304 S/S	SS737
	Ivory	—	—	430 S/S	—
	White	—	—		
 1-Gang; 1-single; 2.15 in. (54.6) dia. opening	Almond	NP724AL	NPJ724AL	Aluminum	SA723
	Black	NP724BK	NPJ724BK	Brass	①
	Brown	NP724	NPJ724	Brass Plated	①
	Gray	NP724GY	NPJ724GY	Chrome	SCH723
	Ivory	NP724I	NPJ724I	302/304 S/S	SS723
	White	NP724W	NPJ724W	430 S/S	SS723L
 2-Gang; 1-single; 2.15 in. (54.6) dia. opening	Almond	NP703AL	NPJ703AL	Aluminum	—
	Black	NP703BK	NPJ703BK	Brass	—
	Brown	NP703	NPJ703	Brass Plated	—
	Gray	NP703GY	NPJ703GY	Chrome	—
	Ivory	NP703I	NPJ703I	302/304 S/S	SS703
	White	NP703W	NPJ703W	430 S/S	SS703L
 2-Gang; 1-single; 2.15 in. (54.6) dia. opening	Almond	—	—	Aluminum Brass	—
	Black	—	—	Brass Plated	—
	Brown	—	—	Chrome	SCH702
	Gray	—	—	302/304 S/S	SS702
	Ivory	—	—	430 S/S	—
	White	—	—		
 2-Gang, 1-single; 2.48 in. (63.0) dia. opening	Almond	—	—	Aluminum Brass	—
	Black	—	—	Brass Plated	—
	Brown	—	—	Chrome	—
	Gray	—	—	302/304 S/S	SS701
	Ivory	—	—	430 S/S	—
	White	—	—		
 2-Gang, 1-single; 2.66 in. (67.6) dia. opening	Almond	—	—	Aluminum Brass	—
	Black	—	—	Brass Plated	—
	Brown	—	—	Chrome	—
	Gray	—	—	302/304 S/S	SS716
	Ivory	—	—	430 S/S	—
	White	—	—		







Note: All standard and mid-size nylon wallplates feature pre-inserted captive screws for faster assembly.
 ① Available as a custom wallplate; see page O-16.

Wallplates

Telephone and Coaxial Wallplates

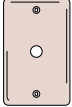
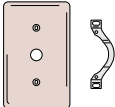
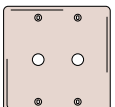

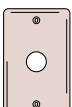
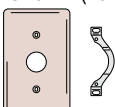
TELEPHONE AND COAXIAL WALLPLATES Inches (mm)

Description	Nylon Color	Standard	Mid-Size	Material	Metal
1-Gang; 1-telephone; .375 in. (9.7) hole; box mount 	Almond	—	—	Brass	①
	Brown	—	—	Brass Plated	①
	Ivory	—	—	Chrome	①
	White	—	—	302/304 S/S 430 S/S	SS739 ①
1-Gang; 1-telephone; .375 in. (9.7) hole; strap mount 	Almond	—	—	Brass	①
	Brown	—	—	Brass Plated	SB738
	Ivory	—	—	Chrome	①
	White	—	—	302/304 S/S 430 S/S	SS738 ①
1-Gang; 1-telephone; .406 in. (10.3) hole; box mount 	Almond	NP11AL	NPJ11AL	Brass	①
	Black	NP11BK	—	Brass Plated	SBP11*
	Brown	NP11	NPJ11	Chrome	①
	Gray	NP11GY	—	302/304 S/S	SS11*
	Ivory	NP11I	NPJ11I	430 S/S	SS11L*
	Light Almond	NP11LA	NPJ11LA		
1-Gang; 1-telephone; .406 in. (10.3) hole; strap mount 	Almond	NP12AL	—	Brass	SB12*
	Black	NP12BK	—	Brass Plated	SBP12*
	Brown	NP12	—	Chrome	SCH12*
	Gray	NP12GY	—	302/304 S/S	SS12*
	Ivory	NP12I	—	430 S/S	①
	White	NP12W	—		
2-Gang; 2-telephone; .406 in. (10.3) hole; box mount 	Almond	NP21AL	—	Brass	—
	Brown	NP21	—	Brass Plated	—
	Ivory	NP21I	—	Chrome	—
	White	NP21W	—	302/304 S/S 430 S/S	① ①
2-Gang; 2-telephone; .406 in. (10.3) hole; strap mount 	Almond	—	—	Brass	—
	Brown	—	—	Brass Plated	—
	Ivory	—	—	Chrome	—
	White	—	—	302/304 S/S 430 S/S	SS22* ①
1-Gang; 1-telephone; .625 in. (15.9) hole; box mount 	Almond	NP737AL	—	Brass	—
	Brown	NP737	—	Brass Plated	—
	Ivory	NP737I	—	Chrome	—
	White	NP737W	—	302/304 S/S 430 S/S	— —
1-Gang; 1-telephone; .625 in. (15.9) hole; strap mount 	Almond	NP730AL	—	Brass	—
	Brown	NP730	—	Brass Plated	—
	Ivory	NP730I	—	Chrome	—
	White	NP730W	—	302/304 S/S 430 S/S	— —
2-Gang; 1-telephone; .64 in. (16.3) hole; box mount 	Almond	—	—	Brass	—
	Brown	—	—	Brass Plated	—
	Ivory	—	—	Chrome	—
	White	—	—	302/304 S/S 430 S/S	SS741* ①

Note: All standard and mid-size nylon wallplates feature pre-inserted captive screws for faster assembly.

① Available as a custom wallplate; see page O-16.







* .50" (12.7) nylon bushing provided.

Wallplates

"D" Hole Wallplates





"D" HOLE WALLPLATES Inches (mm)

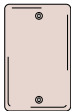
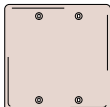
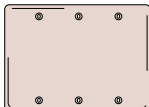

Description	Nylon Color	Standard	Mid-Size	Material	Metal
 1-Gang; 1-"D" hole; .51 in. (12.9) dia.; .44 in. (11.2) flat; box mount	Almond	—	—	Aluminum	①
	Black	—	—	Brass	①
	Brown	—	—	Brass Plated	①
	Gray	—	—	Chrome	①
	Ivory	—	—	302/304 S/S	SSD1422
	White	—	—	430 S/S	①
	 1-Gang; 2-"D" hole; .51 in. (12.9) dia.; .44 in. (11.2) flat; box mount	Almond	—	—	Aluminum
Black		—	—	Brass	①
Brown		—	—	Brass Plated	①
Gray		—	—	Chrome	①
Ivory		—	—	302/304 S/S	SSD1423
White		—	—	430 S/S	①
 1-Gang; 2-"D" hole; .51 in. (12.9) dia.; .44 in. (11.2) flat; box mount		Almond	—	—	Aluminum
	Black	—	—	Brass	①
	Brown	—	—	Brass Plated	①
	Gray	—	—	Chrome	①
	Ivory	—	—	302/304 S/S	SSD1426
	White	—	—	430 S/S	①
	 1-Gang; 1-"D" hole; .58 in. (14.7) dia.; .55 in. (14.0) flat; box mount	Almond	—	—	Aluminum
Black		—	—	Brass	①
Brown		—	—	Brass Plated	①
Gray		—	—	Chrome	①
Ivory		—	—	302/304 S/S	SSD1428
White		—	—	430 S/S	①
 1-Gang; 2-"D" hole; .58 in. (14.7) dia.; .55 in. (14.0) flat; box mount		Almond	—	—	Aluminum
	Black	—	—	Brass	①
	Brown	—	—	Brass Plated	①
	Gray	—	—	Chrome	①
	Ivory	—	—	302/304 S/S	SSD1429
	White	—	—	430 S/S	①
	 1-Gang; 1-"D" hole; .76 in. (19.3) dia.; .73 in. (18.5) flat; box mount	Almond	—	—	Aluminum
Black		—	—	Brass	①
Brown		—	—	Brass Plated	①
Gray		—	—	Chrome	①
Ivory		—	—	302/304 S/S	SSD1430
White		—	—	430 S/S	①

Note: ① Available as a custom wallplate; see page O-16.

BLANK BOX MOUNT WALLPLATES

Description	Nylon Color	Standard	Mid-Size	Material	Metal
	Almond	NP13AL	NPJ13AL	Aluminum	SA13
	Black	NP13BK	NPJ13BK	Brass	SB13
	Brown	NP13	NPJ13	Brass Plated	SBP13
	Gray	NP13GY	NPJ13GY	Chrome	SCH13
	Ivory	NP13I	NPJ13I	302/304 S/S	SS13
	Light Almond	NP13LA	NPJ13LA	430 S/S	SS13L
	White	NP13W	NPJ13W		
	Almond	NP23AL	NPJ23AL	Aluminum	SA23
	Black	NP23BK	—	Brass	SB23
	Brown	NP23	NPJ23	Brass Plated	SBP23
	Gray	NP23GY	—	Chrome	SCH23
	Ivory	NP23I	NPJ23I	302/304 S/S	SS23
	Light Almond	NP23LA	NPJ23LA	430 S/S	SS23L
	White	NP23W	NPJ23W		
	Almond	NP33AL	—	Aluminum	①
	Brown	NP33	—	Brass	①
	Ivory	NP33I	—	Brass Plated	SBP33
	White	NP33W	—	Chrome	①
				302/304 S/S	SS33
			430 S/S	①	
	Almond	NP43AL	—	Aluminum	①
	Brown	NP43	—	Brass	①
	Ivory	NP43I	—	Brass Plated	①
	White	NP43W	—	Chrome	①
				302/304 S/S	SS43
			430 S/S	①	

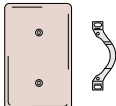
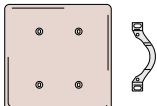
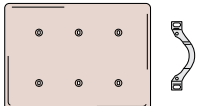
BLANK STRAP MOUNT WALLPLATES

Description	Nylon Color	Standard	Mid-Size	Material	Metal
	Almond	NP14AL	—	Brass	SB14
	Black	NP14BK	—	Brass Plated	①
	Brown	NP14	—	Chrome	①
	Gray	NP14GY	—	302/304 S/S	SS14
	Ivory	NP14I	—	430 S/S	SS14L
	Light Almond	NP14W	—		
	White				
	Almond	NP24AL	—	Brass	①
	Black	NP24BK	—	Brass Plated	①
	Brown	NP24	—	Chrome	①
	Gray	NP24GY	—	302/304 S/S	SS24
	Ivory	NP24I	—	430 S/S	SS24L
	White	NP24W	—		
	Almond	NP34AL	—	Brass	①
	Brown	NP34	—	Brass Plated	①
	Ivory	NP34I	—	Chrome	①
	White	NP34W	—	302/304 S/S	SS34
				430 S/S	①
	Almond	NP44AL	—	Brass	①
	Brown	NP44	—	Brass Plated	①
	Ivory	NP44I	—	Chrome	①
	White	NP44W	—	302/304 S/S	SS44
				430 S/S	①

Note: All standard and mid-size nylon wallplates feature pre-inserted captive screws for faster assembly.

① Available as a custom wallplate; see page O-16.

Wallplates

Combination Wallplates

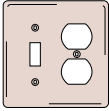
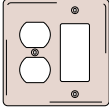
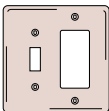
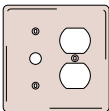
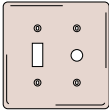
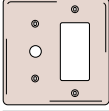
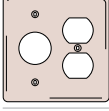
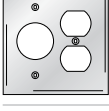
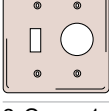
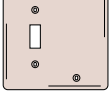
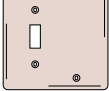

COMBINATION WALLPLATES Inches (mm)

Description	Nylon Color	Standard	Mid-Size	Material	Metal
 2-Gang; 1-toggle; 1-duplex	Almond	NP18AL	NPJ18AL	Aluminum	①
	Black	NP18BK	NPJ18BK	Brass	SB18
	Brown	NP18	NPJ18	Brass Plated	SBP18
	Gray	NP18GY	NPJ18GY	Chrome	SCH18
	Ivory	NP18I	NPJ18I	302/304 S/S	SS18
	Light Almond	NP18LA	NPJ18LA	430 S/S	SS18L
White	NP18W	NPJ18W			
 2-Gang; 1-duplex; 1-decorator	Almond	NP826AL	NPJ826AL	Aluminum	①
	Black	NP826BK	NPJ826BK	Brass	SB826
	Brown	NP826	NPJ826	Brass Plated	①
	Gray	NP826GY	NPJ826GY	Chrome	①
	Ivory	NP826I	NPJ826I	302/304 S/S	SS826
	Light Almond	NP826LA	NPJ826LA	430 S/S	①
White	NP826W	NPJ826W			
 2-Gang; 1-toggle; 1-decorator	Almond	NP126AL	NPJ126AL	Aluminum	①
	Black	NP126BK	NPJ126BK	Brass	SB126
	Brown	NP126	NPJ126	Brass Plated	SBP126
	Gray	NP126GY	NPJ126GY	Chrome	①
	Ivory	NP126I	NPJ126I	302/304 S/S	SS126
	Light Almond	NP126LA	NPJ126LA	430 S/S	SS126L
White	NP126W	NPJ126W			
 2-Gang; 1-telephone .41 in. (10.3) hole; 1-duplex; strap mount	Almond	NP128AL	—	Aluminum	—
	Brown	NP128	—	Brass	—
	Ivory	NP128I	—	Brass Plated	—
	White	NP128W	—	Chrome	—
 2-Gang; 1-toggle; 1-telephone .41 in. (10.3) hole; strap mount	Almond	NP112AL	—	Aluminum	—
	Brown	NP112	—	Brass	—
	Ivory	NP112I	—	Brass Plated	—
	White	NP112W	—	Chrome	—
 2-Gang; 1-telephone .41 in. (10.3) hole; 1-decorator; strap mount	Almond	NP1226AL	—	Aluminum	—
	Brown	NP1226	—	Brass	—
	Ivory	NP1226I	—	Brass Plated	—
	White	NP1226W	—	Chrome	—
 2-Gang; 1-single receptacle 1.40 in. (35.6) dia. opening; 1-duplex	Almond	NP78AL	—	Aluminum	①
	Brown	NP78	—	Brass	①
	Ivory	NP78I	—	Brass Plated	①
	White	NP78W	—	Chrome	①
 2-Gang; 1-single receptacle 1.60 in. (40.6) dia. opening; 1-duplex	Almond	—	—	Aluminum	①
	Brown	—	—	Brass	①
	Ivory	—	—	Brass Plated	①
	White	—	—	Chrome	①
 2-Gang; 1-toggle; 1-single receptacle 1.40 in. (35.6) dia. opening	Almond	NP17AL	—	Aluminum	①
	Black	NP17BK	—	Brass	①
	Brown	NP17	—	Brass Plated	①
	Gray	NP17GY	—	Chrome	①
 2-Gang; 1-toggle; 1-blank; box mount	Ivory	NP17I	—	302/304 S/S	SS17
	White	NP17W	—	430 S/S	①
	Almond	NP113AL	NPJ113AL	Aluminum	①
	Brown	NP113	NPJ113	Brass	①
 2-Gang; 1-toggle; 1-blank; box mount	Ivory	NP113I	NPJ113I	Brass Plated	①
	Light Almond	NP113LA	NPJ113LA	Chrome	①
	White	NP113W	NPJ113W	302/304 S/S	SS113
				430 S/S	①

Note: All standard and mid-size nylon wallplates feature pre-inserted captive screws for faster assembly.
① Available as a custom wallplate; see page O-16.

Wallplates

Combination Wallplates

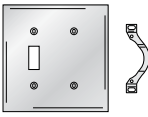
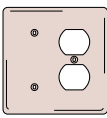
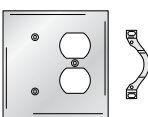
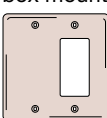
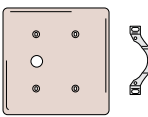
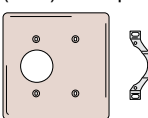
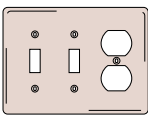
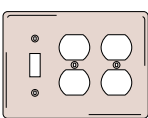

COMBINATION WALLPLATES Inches (mm)

Description	Nylon Color	Standard	Mid-Size	Material	Metal
2-Gang; 1-toggle; 1-blank; strap mount 	Almond	—	—	Aluminum	①
	Brown	—	—	Brass	①
	Ivory	—	—	Brass Plated	①
	Light Almond	—	—	Chrome	①
	White	—	—	302/304 S/S 430 S/S	SS114 ①
2-Gang; 1-blank; 1-duplex; box mount 	Almond	NP138AL	NPJ138AL	Aluminum	①
	Brown	NP138	NPJ138	Brass	①
	Ivory	NP138I	NPJ138I	Brass Plated	①
	White	NP138W	NPJ138W	Chrome	①
				302/304 S/S 430 S/S	SS138 ①
2-Gang; 1-blank; 1-duplex; strap mount 	Almond	—	—	Aluminum	①
	Brown	—	—	Brass	①
	Ivory	—	—	Brass Plated	①
	White	—	—	Chrome	①
				302/304 S/S 430 S/S	SS148 ①
2-Gang; 1-blank; 1-decorator; box mount 	Almond	NP1326AL	NPJ1326AL	Aluminum	①
	Black	NP1326BK	—	Brass	①
	Brown	NP1326	NPJ1326	Brass Plated	①
	Gray	NP1326GY	—	Chrome	①
	Ivory	NP1326I	NPJ1326I	302/304 S/S	SS1426
	Light Almond	NP1326LA	NPJ1326LA	430 S/S	①
	White	NP1326W	NPJ1326W		
2-Gang; 1-telephone .41 in. (10.3) hole; 1-blank; strap mount 	Almond	NP1214AL	—	Aluminum	—
	Brown	NP1214	—	Brass	—
	Ivory	NP1214I	—	Brass Plated	—
	White	NP1214W	—	Chrome	—
				302/304 S/S 430 S/S	—
2-Gang; 1-single receptacle 1.40 in. (35.6) dia. opening; 1-blank; strap mount 	Almond	NP147AL	—	Aluminum	—
	Black	NP147BK	—	Brass	—
	Brown	NP147	—	Brass Plated	—
	Gray	NP147GY	—	Chrome	—
	Ivory	NP147I	—	302/304 S/S	—
	White	NP147W	—	430 S/S	—
3-Gang; 2-toggle; 1-duplex 	Almond	NP28AL	NPJ28AL	Aluminum	①
	Black	NP28BK	—	Brass	①
	Brown	NP28	NPJ28	Brass Plated	SBP28
	Gray	NP28GY	—	Chrome	①
	Ivory	NP28I	NPJ28I	302/304 S/S	SS28
	Light Almond	NP28LA	NPJ28LA	430 S/S	①
	White	NP28W	NPJ28W		
3-Gang; 1-toggle; 2-duplex 	Almond	NP182AL	—	Aluminum	①
	Brown	NP182	—	Brass	①
	Ivory	NP182I	—	Brass Plated	①
	White	NP182W	—	Chrome	①
				302/304 S/S 430 S/S	SS182 ①

Note: All standard and mid-size nylon wallplates feature pre-inserted captive screws for faster assembly.

① Available as a custom wallplate; see page O-16.

Wallplates

Combination Wallplates

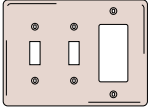
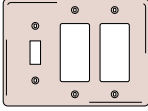
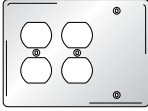
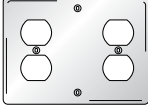
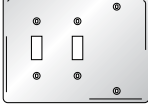
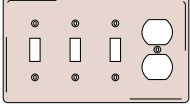
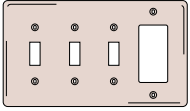
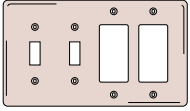
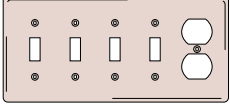

COMBINATION WALLPLATES

Description	Nylon Color	Standard	Mid-Size	Material	Metal
 3-Gang; 2-toggle; 1-decorator	Almond	NP226AL	NPJ226AL	Aluminum	①
	Black	NP226BK	NPJ226BK	Brass	①
	Brown	NP226	NPJ226	Brass Plated	①
	Gray	NP226GY	NPJ226GY	Chrome	①
	Ivory	NP226I	NPJ226I	302/304 S/S	SS226
	Light Almond	NP226LA	NPJ226LA	430 S/S	①
	White	NP226W	NPJ226W		
 3-Gang; 1-toggle; 2-decorator	Almond	NP1262AL	—	Aluminum	①
	Black	NP1262BK	—	Brass	①
	Brown	NP1262	—	Brass Plated	①
	Gray	NP1262GY	—	Chrome	①
	Ivory	NP1262I	—	302/304 S/S	①
	Light Almond	NP1262LA	—	430 S/S	①
	White	NP1262W	—		
 3-Gang; 2-duplex; 1-blank; box mount	Almond	—	—	Aluminum	①
	Brown	—	—	Brass	①
	Ivory	—	—	Brass Plated	①
	White	—	—	Chrome	①
					302/304 S/S
				430 S/S	①
 3-Gang; 1-duplex; 1-blank; 1-duplex; box mount	Almond	—	—	Aluminum	①
	Brown	—	—	Brass	①
	Ivory	—	—	Brass Plated	①
	White	—	—	Chrome	①
					302/304 S/S
				430 S/S	①
 3-Gang; 2-toggle; 1-blank; box mount	Almond	—	—	Aluminum	—
	Brown	—	—	Brass	—
	Ivory	—	—	Brass Plated	—
	White	—	—	Chrome	—
					302/304 S/S
				430 S/S	①
 4-Gang; 3-toggle; 1-duplex	Almond	NP38AL	—	Aluminum	①
	Brown	NP38	—	Brass	①
	Ivory	NP38I	—	Brass Plated	①
	Light Almond	NP38LA	—	Chrome	①
	White	NP38W	—	302/304 S/S	SS38
					430 S/S
 4-Gang; 3-toggle; 1-decorator	Almond	NP326AL	—	Aluminum	①
	Black	NP326BK	—	Brass	①
	Brown	NP326	—	Brass Plated	①
	Gray	NP326GY	—	Chrome	①
	Ivory	NP326I	—	302/304 S/S	SS326
	Light Almond	NP326LA	—	430 S/S	①
	White	NP326W	—		
 4-Gang; 2-toggle; 2-decorator	Almond	NP2262AL	—	Aluminum	①
	Black	NP2262BK	—	Brass	①
	Brown	NP2262	—	Brass Plated	①
	Gray	NP2262GY	—	Chrome	①
	Ivory	NP2262I	—	302/304 S/S	①
	Light Almond	NP2262LA	—	430 S/S	①
	White	NP2262W	—		
 5-Gang; 4-toggle; 1-duplex	Almond	NP48AL	—	Aluminum	①
	Brown	NP48	—	Brass	①
	Ivory	NP48I	—	Brass Plated	①
	White	NP48W	—	Chrome	①
					302/304 S/S
				430 S/S	①





Note: All standard and mid-size nylon wallplates feature pre-inserted captive screws for faster assembly.

① Available as a custom wallplate; see page O-16.

RS232 WALLPLATES

Description	Nylon Color	Standard	Mid-Size	Material	Metal
1-Gang; 1- 25-pin opening 	Almond	—	—	Aluminum	①
	Black	—	—	Brass	①
	Brown	—	—	Brass Plated	①
	Gray	—	—	Chrome	①
	Ivory	—	—	302/304 S/S	SS232
	White	—	—	430 S/S	①
1-Gang; 2- 25-pin openings 	Almond	—	—	Aluminum	①
	Black	—	—	Brass	①
	Brown	—	—	Brass Plated	①
	Gray	—	—	Chrome	①
	Ivory	—	—	302/304 S/S	SS234
	White	—	—	430 S/S	①

RJ11 AND RJ45 MODULAR JACK WALLPLATES Inches (mm)

Description	Nylon Color	Standard	Mid-Size	Material	Metal
1-Gang; 1- .59 in. x .76 in. (15.0 x 19.3) opening 	Almond	—	—	Aluminum	①
	Black	—	—	Brass	①
	Brown	—	—	Brass Plated	①
	Gray	—	—	Chrome	①
	Ivory	—	—	302/304 S/S	SST1473
	White	—	—	430 S/S	①
1-Gang; 2- .59 in. x .76 in. (15.0 x 19.3) opening 	Almond	—	—	Aluminum	①
	Black	—	—	Brass	①
	Brown	—	—	Brass Plated	①
	Gray	—	—	Chrome	①
	Ivory	—	—	302/304 S/S	SST1474
	White	—	—	430 S/S	①
2-Gang; 4- .59 in. x .76 in. (15.0 x 19.3) opening 	Almond	—	—	Aluminum	①
	Black	—	—	Brass	①
	Brown	—	—	Brass Plated	①
	Gray	—	—	Chrome	①
	Ivory	—	—	302/304 S/S	SST2474
	White	—	—	430 S/S	①
1-Gang; 1- .59 in. x .82 in. (15.0 x 20.8) opening 	Almond	—	—	Aluminum	①
	Black	—	—	Brass	①
	Brown	—	—	Brass Plated	①
	Gray	—	—	Chrome	①
	Ivory	—	—	302/304 S/S	SST1476
	White	—	—	430 S/S	①
1-Gang; 2- .59 in. x .82 in. (15.0 x 20.8) opening 	Almond	—	—	Aluminum	①
	Black	—	—	Brass	①
	Brown	—	—	Brass Plated	①
	Gray	—	—	Chrome	①
	Ivory	—	—	302/304 S/S	SST1477
	White	—	—	430 S/S	①

LOUVER WALLPLATES

Description	Nylon Color	Standard	Mid-Size	Material	Metal
1-Gang; vertical box mounted 	Almond	—	—	Aluminum	①
	Black	—	—	Brass	SB771
	Brown	—	—	Brass Plated	SBP771
	Gray	—	—	Chrome	①
	Ivory	—	—	302/304 S/S	SS771
	White	—	—	430 S/S	①









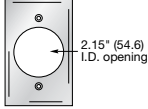

Note: ① Available as a custom wallplate; see page O-16.

Wallplates

Jumbo Metal Wallplates

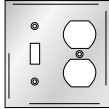

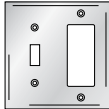
JUMBO, STAINLESS STEEL, BRUSHED FINISH Inches (mm)

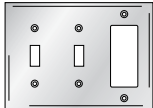
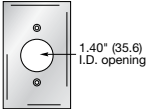
Description	Material	Catalog Number	Description	Material	Catalog Number
1-Gang; 1-toggle 	302/304 S/S 430 S/S	SSJ1 —	1-Gang; 1-single receptacle 2.09–2.13 in. (53.1–54.1) dia. opening 	302/304 S/S 430 S/S	SSJ723 —
2-Gang; 2-toggle 	302/304 S/S 430 S/S	SSJ2 —	1-Gang; blank; box mount 	302/304 S/S 430 S/S	SSJ13 —
1-Gang; 1-duplex 	302/304 S/S 430 S/S	SSJ8 —	1-Gang; 1-telephone .64 in. (16.3) hole; box mount 	302/304 S/S 430 S/S	SSJ11* —
2-Gang; 2-duplex 	302/304 S/S 430 S/S	SSJ82 —	2-Gang; 1-toggle; 1-duplex 	302/304 S/S 430 S/S	SSJ18 —
1-Gang; 1-decorator 	302/304 S/S 430 S/S	SSJ26 —	2-Gang; 1-toggle; 1-decorator 	302/304 S/S 430 S/S	SSJ126 —
2-Gang; 2-decorator 	302/304 S/S 430 S/S	SSJ262 —	3-Gang; 2-toggle; 1-decorator 	302/304 S/S 430 S/S	SSJ226 —
1-Gang; 1-single receptacle 1.36–1.39 in. (34.5–35.3) dia. opening 	302/304 S/S 430 S/S	SSJ7 —			

Note: * .50" (12.7) nylon bushing provided.

Jumbo Metal Wallplate Dimensions

1-Gang; 5.25 in. x 3.50 in. (133.4 x 88.9)

2-Gang; 5.25 in. x 5.31 in. (133.4 x 134.9)

3-Gang; 5.25 in. x 7.12 in. (133.4 x 180.8)

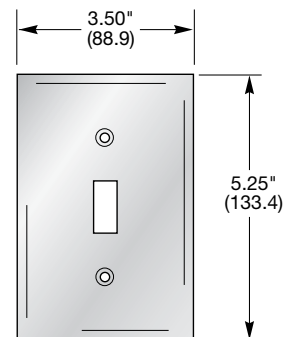

HOW TO SELECT A CUSTOM METAL WALLPLATE

Step 1:

Determine wallplate material and enter in box marked "Catalog Number"

Smooth Metal Material	Code
Aluminum	AL
Brass plated steel	BP
Solid brass	BR
Chrome plated steel	CH
Stainless steel 302/304	SS
Stainless steel 430	SL

Determine number of gangs required and enter in box marked "Catalog Number" next to material.

Number of Gangs	Code
1-Gang	1
2-Gang	2
3-Gang	3
4-Gang	4
5-Gang	5
6-Gang	6
7-Gang	7
8-Gang	8

Enter Catalog Number.

◆ **BWC*** **SS** **4**

Step 2:

Enter quantity.

Step 3:

Select the custom metal wallplate configuration. Refer to the custom wallplate configuration chart to select a configuration for each gang in the wallplate. Each configuration has a specific 3-digit code located in the chart on page O-17. Enter this 3-digit configuration code in the corresponding box on the order form grid to match the position required on the finished custom wallplate.







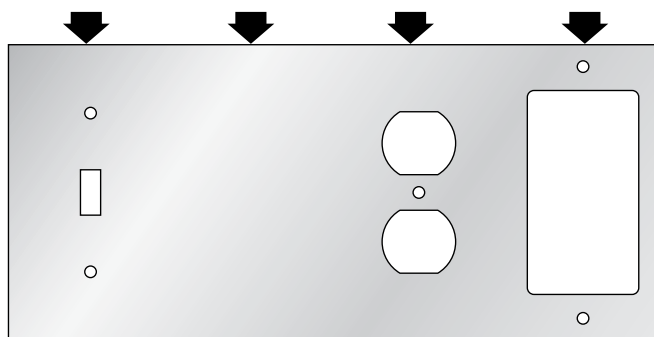



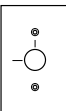
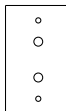
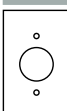
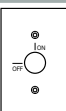

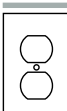
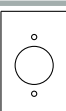
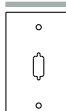
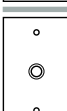
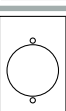
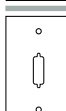
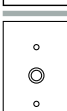

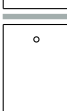

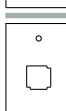
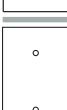
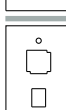
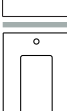
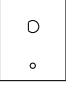
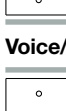

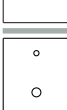



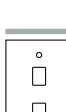

Item No.	Catalog Number	Quantity	Position 1	Position 2	Position 3	Position 4
1	BWCSS4		001	149	008	026
2						

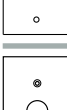
Note: *BWC are preprinted on the distributor order form.
◆ Number to use for pricing.

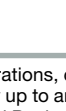
The 3-digit numbers listed in the Sample Order Form above (001, 149, etc.) represent the configuration for the custom metal wallplate selected on the right. See Configuration Chart and Bryant Configuration Selector Guide on page O-17 for additional configuration choices.



CONFIGURATION CHART Inches (mm)

	001 Toggle switch		079 Barrel key switch with hash marks		456 2-Telephone .38 in. (9.7) dia. hole; box mount
	007 Single receptacle; 1.40 in. (35.6) I.D. opening		080 Barrel key switch with ON/OFF and hash marks		458 2-Telephone .50 in. (12.7) dia. hole; box mount
	008 Duplex receptacle		091 Single receptacle; 1.60 in. (40.6) I.D. opening		411 2-Telephone .64 in. (16.3) dia. hole; box mount
	011 1-Telephone .64 in. (16.3) I.D. hole; box mount; .50 in. (12.7) I.D.; nylon bushing		098 Single receptacle; 2.16 in. (54.7) I.D. opening		435 9-Pin; vertical box mount
	012 1-Telephone .64 in. (16.3) I.D. hole; strap mount; .50 in. (12.7) I.D.; nylon bushing		135 Louver; vertical mount		438 15-Pin; vertical box mount
	013 Blank; box mount		149 Blank; no mounting holes		295 25-Pin; vertical box mount
	014 Blank; strap mount	Coax/Twinax and Modular Jack Openings			314 1-IBM® type opening; box mount
	026 Decorator opening		422 1-"D" hole; .51 in. (12.9) dia.; .44 in. (11.2) flat; box mount		415 1-IBM® type opening; 1- .59 in. X .76 in. (15.0 X 19.3) opening
	055 1-Telephone; .38 in. (9.7) I.D. hole; strap mount		425 1-"D" hole; .51 in. (12.9) dia.; .47 in. (12.0) flat; box mount	Voice/Data Opening	
	056 1-Telephone; .38 in. (9.7) I.D. hole; box mount		428 1-"D" hole; .58 in. (14.7) dia.; .55 in. (14.0) flat; box mount		470 1- .54 in. X .75 in. (13.8 X 19.1) opening; vertical box mount
	057 1-Telephone; .50 in. (12.7) I.D. hole; strap mount		430 1-"D" hole; .76 in. (19.3) dia.; .73 in. (18.5) flat; box mount		473 1- .59 in. X .76 in. (15.0 X 19.3) opening; vertical box mount
	058 1-Telephone; .50 in. (12.7) I.D. hole; box mount		431 2-"D" hole; .76 in. (19.3) dia.; .73 in. (18.5) flat; box mount		476 1- .59 in. X .82 in. (15.0 X 20.8) opening; vertical box mount
	078 Barrel key switch		423 2-"D" hole; .51 in. (12.9) dia.; .44 in. (11.2) flat; box mount		479 1- .58 in. X .78 in. (14.6 X 19.8) opening; vertical box mount
			426 2-"D" hole; .51 in. (12.9) dia.; .47 in. (12.0) flat; box mount		471 2- .54 in. X .75 in. (13.8 X 19.1) opening; vertical box mount
			429 2-"D" hole; .58 in. (14.7) dia.; .55 in. (14.0) flat; box mount		474 2- .59 in. X .76 in. (15.0 X 19.3) opening; vertical box mount
			431 2-"D" hole; .76 in. (19.3) dia.; .73 in. (18.5) flat; box mount		477 2- .59 in. X .82 in. (15.0 X 20.8) opening; vertical box mount
					480 2- .58 in. X .78 in. (14.6 X 19.8) opening; vertical box mount

Note: For detailed dimensions of the above configurations, contact Technical Service at techserv@hubbell.com. Available in brushed metal, standard size only up to and including 8-gang type. IBM® is a registered trademark of International Business Machines Corporation.

“EMERGENCY” WALLPLATES



Description	302/304 Stainless Steel; Standard Size; Engraved Red Filled Lettering	Red Nylon; Mid-Size; Hot Stamped White Lettering
1-Gang; 1-duplex	SS8MEV	NPJ8RMEV
2-Gang; 2-duplex	SS82MEV	N2202MEM
1-Gang; 1-toggle	SS1ME	NPJ1RME

Note: All lettering is ¼ inch (6.4 mm) high.

“ISOLATED GROUND” Inches (mm)

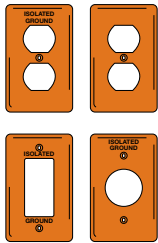

Description	Orange Nylon; Standard-Size; Hot Stamped Black Lettering
1-Gang; 1-duplex	NP80IG
1-Gang; 1-duplex; no marking	NP80R
1-Gang; 1-decorator	NP260IG
1-Gang; 1-single receptacle 1.40 in. (35.6) dia. opening for receptacles with face diameter 1.36–1.39 in. (34.5–35.3)	NP70IG
1-Gang; 1-single receptacle 1.60 in. (40.6) dia. opening for 20A and 30A locking receptacles with face diameter 1.55–1.58 in. (39.4–40.1)	NP7200IG

Note: All lettering is ¼ inch (6.4 mm) high.

“COMPUTER ONLY” WALLPLATES

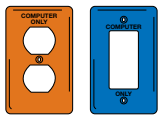

Description	Orange Nylon; Mid-Size; Hot Stamped Black Lettering	Ivory Nylon; Mid-Size; Hot Stamped Black Lettering	Blue Nylon; Mid-Size; Hot Stamped Black Lettering
1-Gang; 1-duplex	NPJ8CO	NPJ8C	—
1-Gang; 1-decorator	—	NPJ26C	NPJ26CBL
2-Gang; 2-duplex	NPJ82CO	—	—

Note: All lettering is ¼ inch (6.4 mm) high.

OIL AND GAS BURNER EMERGENCY PLATES Inches (mm)

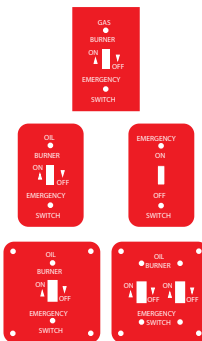

Description	Oil Burner Cover	Gas Burner Cover	Emergency Cover
1-Gang; 1-toggle; ¼ in. (6.4) silk screened white letters on red enameled steel	S22710EM	S2271GEM	—
Utility/handy box cover; 1-toggle; ¼ in. (6.4) silk screened white letters on red enameled steel	SY8650EM	SY865GEM	SY865EM
4 in. (101.6) square box cover; 1-toggle; ¼ in. (6.4) silk screened white letters on red enameled steel	SY8000EM	SY800GEM	—
4 in. (101.6) square box cover; 2-toggle; ¼ in. (6.4) silk screened white letters on red enameled steel	—	SY803GEM	—

“LOCKING” WALLPLATES AND ACCESSORIES



Description	Catalog Number	
	1-Gang	2-Gang
302 stainless steel with on/off marking	SS12RKKL	SS22RKKL
302 stainless steel with position marking	SS12RKLM	SS22RKLM
Accessories		
Tamper proof wallplate screws ½ in.; 302 SS spanner head	SSTP12	
Spanner head screw driver	SSTPD	
Replacement barrel key	6006RKLM	



ADAPTERS Inches (mm)

Description	Color	Catalog Number
1-Gang; decorator frame adapter .41 in. (10.3) diameter hole	Almond	NS621AL
	Ivory	NS621I
	Light Almond	NS621LA
	White	NS621W
1-Gang; blank decorator frame adapter; to fill an unused decorator opening or to adapt for custom application	Almond	NS620AL
	Ivory	NS620I
	Light Almond	NS620LA
	White	NS620W



YOKES**

Description	Color	Catalog Number
Blank toggle adapter; to fill an unused toggle opening	Brown	RA756
	Ivory	RA756I
	White	RA756W
Mounting strap; with screws	Steel	RA40

TAMPERPROOF STAINLESS STEEL PLATE SCREWS TYPE 302/304 AND SCREWDRIVER** Inches (mm)



Description	Length in. (mm)	Catalog Number
Spanner head type 6-32 thread	¼" (3.2)	SSTP14
	⅜" (9.5)	SSTP38
	½" (12.7)	SSTP12
	⅝" (15.9)	SSTP58
	1" (25.4)	SSTP1
	2" (50.8)	SSTP2
Spanner head screwdriver	—	SSTPD

Note: Screws sold in carton quantities of 100.



WALLPLATE SCREWS**

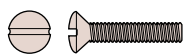

Description	Color/Material	Catalog Number		
		Decorator ⅜" Long	Standard ½" Long	Standard 1" Long
Wallplate screws; oval head milled slot; 6-32 thread; 100 per box (order 1 to receive a box of 100)	Almond	RA38ALPK100	RA12ALPK100	—
	Black	RA38BKPK100	RA12BKPK100	—
	Brown	RA38PK100	RA12PK100	—
	Gray	RA38GYPK100	RA12GYPK100	—
	Ivory	RA38IPK100	RA12IPK100	RA88IPK100
	Light Almond	RA38LAPK100	RA12LAPK100	—
	White	RA38WPK100	RA12WPK100	RA88WPK100
	Brass	RA38BRPK100	RA58BRPK100*	—
	Chrome	RA38CHPK100	RA58CHPK100*	—
	302/304 S/S	RA38SSPK100	RA58SSPK100*	RA88SSPK100

Note: * ⅝ inch long.
** Not UL Listed or CSA Certified.

WALLPLATE SELECTION CHART FOR SINGLE RECEPTACLES Inches (mm)

Typical Receptacle		Matching Wallplate		Stainless Steel 302/304	Stainless Steel 430	Solid Brass	Hi-Impact Nylon			
							Ivory	Brown		
	15 or 20 amp straight blade devices		15 amp locking devices		1-Gang; single receptacle 1.40 (35.6) I.D. opening	SS7	SS7L	SB7	NP7I	NP7*
	20 or 30 amp locking devices 3-wire, 4-wire or 5-wire		20 or 30 amp locking devices 3-wire, 4-wire or 5-wire		1-Gang; single receptacle 1.60 (40.6) I.D. opening	SS720	—	SB720	NP720I	NP720*
	30 or 50 amp 3-wire power outlets		1-Gang; power outlet 2.15 (54.6) I.D. opening	SS723	SS723L	—	NP724I	NP724*		
			2-Gang; power outlet 2.15 (54.6) I.D. opening	SS702	—	—	—	—		
			2-Gang; 2.15 (54.6) I.D. opening 1.81 W. (46.0) x 2.38 H. (60.3) mounting	SS703	SS703L	—	NP703I	NP703*		
	30, 50 or 60 amp 3-wire power outlets		2-Gang; 2.48 (63.0) I.D. opening 1.81 W. (46.0) x 2.38 H. (60.3) mounting	SS701	—	—	—	—		

Note: *Catalog number indicated is Brown, for full offering of color options and materials see page O-7.

Wallplates

Dimensions and Material Specifications



NYLON Inches (mm)

Specifications	
Thickness	.06 in. (1.5)
Mounting Screw(s)	Brass (painted slotted screw head)
Feature	Captive mounting screw hole; positive bow for flush mounting
Operating Temperature	-40°C to 85°C
Appearance	Smooth

ALUMINUM Inches (mm)

Specifications	
Thickness	.05 in. (1.3)
Mounting Screw(s)	Aluminum slotted head
Appearance	Brushed finish; clear anodized

BRASS (70% COPPER, 30% ZINC) Inches (mm)

Specifications	
Thickness	.04 in. (1.0)
Mounting Screw(s)	Brass (70% copper, 30% zinc); slotted screw head
Operating Temperature	-40°C to 85°C
Appearance	Brushed finish

BRASS-PLATED STEEL Inches (mm)

Specifications	
Thickness	.03 in. (.8) nominal
Mounting Screw(s)	Brass slotted head
Appearance	Polished finish; coated to inhibit oxidation

302/304 STAINLESS STEEL (18% CHROMIUM, 8% NICKEL) Inches (mm)

Specifications	
Thickness	.035 in. (.9) nominal
Mounting Screw(s)	302/304 stainless steel (18% chromium, 8% nickel); slotted screw head
Appearance	Brushed finish

430 STAINLESS STEEL (17% CHROMIUM, LESS THAN 0.50% NICKEL) Inches (mm)

Specifications	
Thickness	.035 in. (.9) nominal
Mounting Screw(s)	302/304 stainless steel (18% chromium, 8% nickel); slotted screw head
Appearance	Brushed finish

CHROME-PLATED STEEL Inches (mm)

Specifications	
Thickness	.03 in. (.8) Nominal
Mounting Screw(s)	Zinc-plated steel slotted head
Appearance	Polished finish; coated to inhibit oxidation

NYLON, STAINLESS STEEL AND BRASS

Listings

Conforms to applicable NEMA and ANSI Standards
 Meets UL Standard 514D and CSA C22.2 #42.1
 UL Listed (Brass, Stainless Steel and Nylon)
 CSA Certified

NYLON PRODUCT DIMENSIONS Inches (mm)

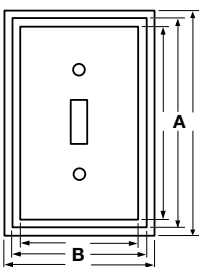

Gang	Standard Size		Mid-Size		Snap-on	
	A	B	A	B	A	B
1-Gang	4.63" (117.6)	2.88" (73.2)	4.88" (124.0)	3.13" (79.5)	4.68" (118.9)	2.94" (74.7)
2-Gang	4.63" (117.6)	4.69" (119.1)	4.88" (124.0)	4.94" (125.4)	4.68" (118.9)	4.75" (120.7)
3-Gang	4.63" (117.6)	6.50" (165.1)	4.88" (124.0)	6.75" (171.5)	4.68" (118.9)	6.56" (166.6)
4-Gang	4.63" (117.6)	8.31" (211.1)	4.88" (124.0)	8.56" (217.4)	4.68" (118.9)	8.37" (212.6)
5-Gang	4.63" (117.6)	10.12" (256.1)	—	—	4.68" (118.9)	10.18" (258.6)
6-Gang	4.63" (117.6)	11.93" (303.0)	—	—	4.68" (118.9)	11.99" (304.5)

METAL PRODUCT DIMENSIONS Inches (mm)

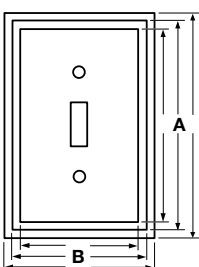

Gang	Standard Size		Mid-Size		Jumbo	
	A	B	A	B	A	B
1-Gang	4.50" (114.3)	2.87" (72.9)	4.88" (124.0)	3.13" (79.5)	5.25" (133.4)	3.50" (88.9)
2-Gang	4.50" (114.3)	4.60" (116.8)	4.88" (124.0)	4.94" (125.5)	5.25" (133.4)	5.31" (134.9)
3-Gang	4.50" (114.3)	6.41" (162.8)	4.88" (124.0)	6.75" (171.5)	5.25" (133.4)	7.12" (180.8)
4-Gang	4.50" (114.3)	8.22" (208.8)	—	—	—	—
5-Gang	4.50" (114.3)	10.03" (254.8)	—	—	—	—
6-Gang	4.50" (114.3)	11.81" (300.0)	—	—	—	—
7-Gang	4.50" (114.3)	13.63" (347.5)	—	—	—	—
8-Gang	4.50" (114.3)	15.44" (392.1)	—	—	—	—

ZINC DIE CAST; 1-GANG; VERTICAL MOUNT Inches (mm)



Description	Dimensions	Catalog Number
	Height x Width x Depth	
1-Duplex; box mount; gray	4.58" x 2.82" x 0.57" (116.3 x 71.6 x 14.5)	RW51470
1-Single receptacle; 1.40 in. (35.6) dia. opening; box mount; gray	4.56" x 2.81" x 0.88" (115.8 x 71.4 x 22.4)	RW51550*
1-Decorator; box mount; gray	4.58" x 2.81" x 0.57" (116.3 x 71.4 x 14.5)	RW51040

ZINC DIE CAST; 1-GANG; HORIZONTAL MOUNT Inches (mm)



Description	Dimensions	Catalog Number
	Height x Width x Depth	
1-Duplex; box mount; gray	2.82" x 4.57" x 0.79" (71.6 x 116.1 x 20.1)	RW51810
1-Single receptacle; 1.40 in. (35.6) dia. opening; box mount; gray	2.81" x 4.56" x 0.99" (71.4 x 115.8 x 25.1)	RW51520*
1-Decorator; box mount; gray	2.82" x 4.56" x 0.52" (71.6 x 115.8 x 11.3)	RW51020

ZINC DIE CAST; 2-GANG; VERTICAL MOUNT Inches (mm)



Description	Dimensions	Catalog Number
	Height x Width x Depth	
2-Duplex; box mount; gray	4.54" x 4.54" x 0.75" (115.3 x 115.3 x 19.1)	RW51320
1-Duplex; 1-decorator; box mount; gray	4.54" x 4.54" x 0.77" (115.3 x 115.3 x 19.6)	RW51330
2-Single receptacle; 1.40 in. (35.6) dia. opening; box mount; gray	4.54" x 4.54" x 0.77" (115.3 x 115.3 x 19.6)	RW51380
2-Decorator; box mount; gray	4.54" x 4.56" x 0.73" (115.3 x 115.8 x 18.5)	RW51450

Note: All weatherproof plates are UL Listed for WET LOCATIONS WITH COVER CLOSED, for intermittent use in wet locations or use in damp locations. All plates are gasketed and self-closing.
*cULus Listed.



7420B



7427B



23007



7770

DIE CAST ALUMINUM; 1-GANG; VERTICAL MOUNT Inches (mm)

Description	Catalog Number
1.62 in. (41.1) dia. opening; 20 and 30 amp; locking receptacle	7420B
2.15 in. (54.6) dia. opening; 30 and 50 amp; 3-wire power receptacle	7427B
2.31 in. (58.7) dia. opening for "MBWP" inlet	7429B
20 amp power interrupting; locking receptacle	23007
30 amp power interrupting; locking receptacle; lift cover	20405
50 amp standard locking receptacle	7770

NON-METALLIC; 1-GANG; VERTICAL MOUNT FOR FLANGED DEVICES

Description	Catalog Number
Yellow fiberglass weatherproof plate with lift lid for 50 amp locking receptacles; fits F.S. and F.D. boxes	7774CR

CATALOG NUMBER FOR RECEPTACLES IN GROUPS Inches (mm)

Boss diameter 1.36" to 1.39" (34.5 to 35.3)		Boss diameter 1.55" to 1.58" (39.4 to 40.1)				Boss diameter 1.68" to 1.72" (42.7 to 43.7)	Boss diameter 2.09" to 2.13" (53.1 to 54.1)	Boss diameter 2.28" to 2.44" (57.9 to 62.0)
5261	8310	70520FR	71220FR	71820FR	3330	9530FR	3771	CS6369L
5251	7250	70620FR	71030FR	71920FR	3430	9630FR	7379	CS6370L
5661	5284	70720FR	71130FR	72020FR	3520	9303	3769	CS8169L
5361	5258	70820FR	71230FR	71830FR	7410	9306	6369CR	CS8269L
5351	5684	70920FR	71330FR	71930FR	40045FR	9550FR	6370CR	CS8369L
5461	5384	70530FR	71420FR	72030FR	FSL1FR	9650FR		CS8469L
4710	5484	70630FR	71520FR	72120FR	FSL2FR			CS6369A
4760	5261IG	70730FR	71620FR	72220FR	FSL3FR			CS6370A
7582	5361IG	70830FR	71430FR	72320FR	FSL4FR			CS8169A
7310	7535	70930FR	71530FR	72130FR				CS8269A
8210	70615FR	71020FR	71630FR	72230FR				CS8369A
		71120FR	71730FR	72330FR				CS8469A

PRODUCT DIMENSIONS Inches (mm)

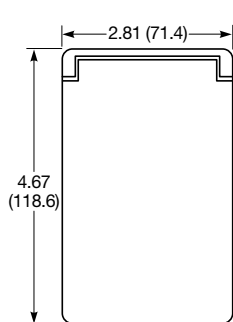

7420B

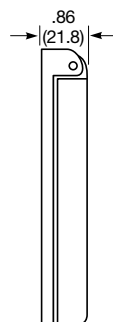

Side

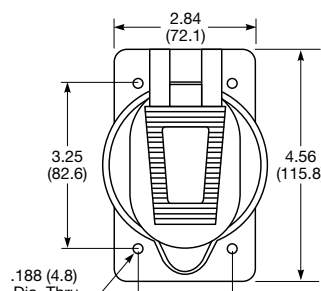

7774CR

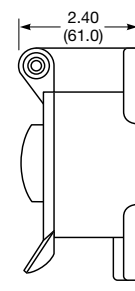



NON-METALLIC; 1-GANG; VERTICAL MOUNT FOR FLANGED DEVICES

Description **Catalog Number**

Weatherproof lift cover for use with 15 amp locking flanged equipment devices (inlets and receptacles)

WPC1

Weatherproof lift cover for use with 20 and 30 amp locking flanged equipment devices (inlets and receptacles)

WPC2

Weatherproof lift cover for use with 50 amp locking non-metallic flanged inlets

7780*

Note: *cULus Listed only; not CSA Certified.

USE WITH FLANGED INLETS AND FLANGED RECEPTACLES LISTED BELOW

Catalog Number	Use with flanged inlets and flanged receptacles listed below							
WPC1	4716MB	4715ER	70615MB	70615ER	4786MB	4785ER	7556MB	7557ER
	8808	8809						
WPC2	70520MB	70520ER	70620MB	70620ER	70720MB	70720ER	70820MB	70820ER
	70920MB	70920ER	70530MB	70530ER	70630MB	70630ER	70730MB	70730ER
	70830MB	70830ER	70930MB	70930ER	7327	7328	71020MB	71020ER
	71120MB	71120ER	71220MB	71220ER	71030MB	71030ER	71230MB	71230ER
	71330MB	71330ER	71420MB	71420ER	71520MB	71520ER	71620MB	71620ER
	71430MB	71430ER	71530MB	71530ER	71630MB	71630ER	71730MB	71730ER
	7408MB	7409ER	71820MB	71820ER	71920MB	71920ER	72020MB	72020ER
	71830MB	71830ER	71930MB	79130ER	72030MB	72030ER	72120MB	72120ER
	72220MB	72220ER	72320MB	72320ER	40045MB	40045ER	72130MB	72130ER
	72230MB	72230ER	72330MB	72330ER				
7780	CS6375L							
	CS8375L							





Note: Device not included.

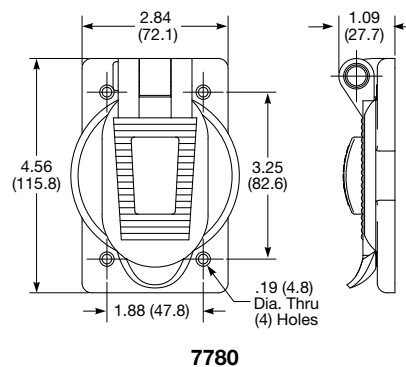
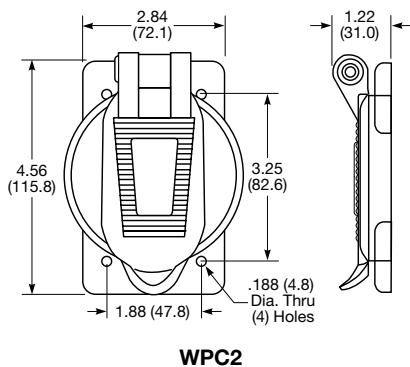

PRODUCT DIMENSIONS Inches (mm)



NON-METALLIC; 1-GANG; WHILE-IN-USE Inches (mm)

Description	Dimensions			Catalog Number
	Height x Width x Depth			
 <p>Vertical mount; four plates included; 1-duplex, 1-decorator, 1-toggle and 1-single receptacle with eight dia. openings to choose from. (1.34 in., 1.41 in., 1.47 in., 1.59 in., 1.66 in., 1.79 in., 2.03 in. and 2.16 in.)</p>	3.88" x 6.00" x 2.88"			RW57300
 <p>Deep cover; vertical mount; four plates included; 1-duplex, 1-decorator, 1-toggle and 1-single receptacle with eight dia. openings to choose from. (1.34 in., 1.41 in., 1.47 in., 1.59 in., 1.66 in., 1.79 in., 2.03 in. and 2.16 in.)</p>	3.88" x 6.00" x 4.88"			RW57350
 <p>Horizontal mount; four plates included; 1-duplex, 1-decorator, 1-toggle and 1-single receptacle with eight dia. openings to choose from. (1.34 in., 1.41 in., 1.47 in., 1.59 in., 1.66 in., 1.79 in., 2.03 in. and 2.16 in.)</p>	5.50" X 4.38" x 2.88"			RW57400

NON-METALLIC; 2-GANG; WHILE-IN-USE Inches (mm)

Description	Dimensions			Catalog Number
	Height x Width x Depth			
 <p>Four plates included; 2-duplex, 2-decorator, 1-toggle and 1-single receptacle with eight dia. openings to choose from. (1.34 in., 1.41 in., 1.47 in., 1.59 in., 1.66 in., 1.79 in., 2.03 in. and 2.16 in.)</p>	5.50" x 6.00" x 2.88"			RW57750
 <p>Deep cover; four plates included; 2-duplex, 2-decorator, 1-toggle and 1-single receptacle with eight dia. openings to choose from. (1.34 in., 1.41 in., 1.47 in., 1.59 in., 1.66 in., 1.79 in., 2.03 in. and 2.16 in.)</p>	5.50" x 6.00" x 4.88"			RW57900
 <p>Deep cover; two plates included; 1-single receptacle with 2.66 in. dia. opening; 1-single receptacle with eight dia. openings to choose from. (1.34 in., 1.41 in., 1.47 in., 1.59 in., 1.66 in., 1.79 in., 2.03 in. and 2.16 in.)</p>	5.50" x 6.00" x 4.88"			RW57950

- 2-Gang; die cast aluminum; weatherproof box; compact design
- 2-Gang; polycarbonate; while-in-use cover; high resistance to impact and corrosion
- 20A 125V or 250V heavy duty locking receptacle
- 20A 120-277V AC switch; single-pole or double-pole
- Locking receptacle prevents accidental disconnection of mating pump plug
- NEMA 3R while-in-use cover; tinted lid aesthetically pleasing for any location



POOL PUMP RECEPTACLE KIT

Description	Catalog Number
20A 125V pool pump receptacle kit; includes a NEMA L5-20 locking receptacle and single pole 20A 120-277V AC switch	PKL520*
20A 250V pool pump receptacle kit; includes a NEMA L6-20 locking receptacle and a double pole 20V 120-277V AC switch	PKL620*

Note: *Includes mounting hardware; gasket; wire connector; (3) closure plugs for the 3/4 inch threaded outlets and assembly instructions.



Locking receptacle helps prevent unintentional disconnection of mating pump plug



While-in-use cover protects switch and receptacle from weather and dirt while in use; and can be locked for added security (lock not included)

- Extra deep weatherproof box gives installers the room needed to wire the box efficiently
- State-of-the-art powder-coated finish provides years of protection against the elements
- Includes hardware; gasket and ground screw are provided
- Male inlet is securely mounted to the cover for additional durability
- Industrial grade device
- 1-Gang; cast aluminum



GENERATOR POWER CONNECTION KIT

Description	Catalog Number
NEMA L14-30; 30A 125/250V; 3-pole 4-wire generator kit	RB58405*

Note: *Includes mounting hardware; gasket; ground screw; (2) closure plugs for the 3/4 inch threaded outlets and assembly instructions.